

# Operation Guide 3M-50

Filtrete

3M

To turn your 3M-50 ON, press the MODE button on the right side. This cycles the 3M-50 through HEAT, COOL, AUTO and OFF modes.

The 3M-50 programmable communicating thermostat operates via a high-quality, easy-to-use touch screen. To program or adjust your 3M-50, simply touch your finger firmly to the screen. The screen will automatically light up and you will hear a “beep.” The screen will respond differently to different types of touches, so you may want to experiment by touching it different ways, finger, fingernail, etc. Do not use a sharp or metallic device; it will scratch the screen.

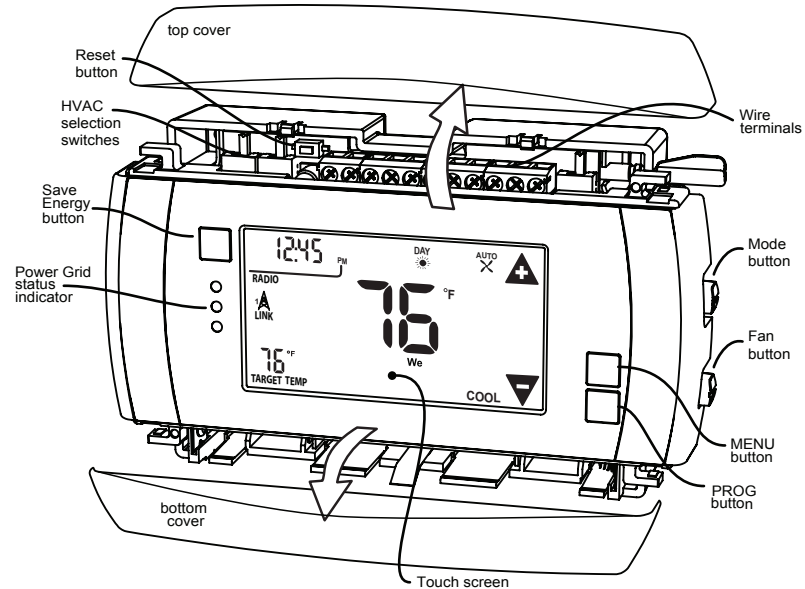

**Statement of use:** 100% Compatible with all popular residential HVAC systems; 24VAC single, two stage conventional heating systems (gas/oil/electric), heat pumps, single stage or with auxiliary heat (electric or fossil), zoned forced air and zoned hot water (2 or 3 wire), millivolt systems (with a 12-24 AC or DC source), one or two stage cooling, and hybrid systems.

## Control Screens

# HOME Screen

Before you operate the 3M-50 please get familiar with these basic control screens. All the 3M-50 functions are accessed through these screens: HOME, MENU, PROGRAM and MANUAL. The 3M-50 touch screen technology allows you to select (by touching) an item and change it using the +/- arrows or the time arrows.

The simple **HOME** screen is displayed when the unit is operating.

Touching the HOME icon  on another screen will always return you to this screen.

To set a Mode:

Press the mode button on the side. The 3M-50 will step through the modes HEAT, OFF, COOL, OFF and AUTO in order. The LCD shows what mode you are in.

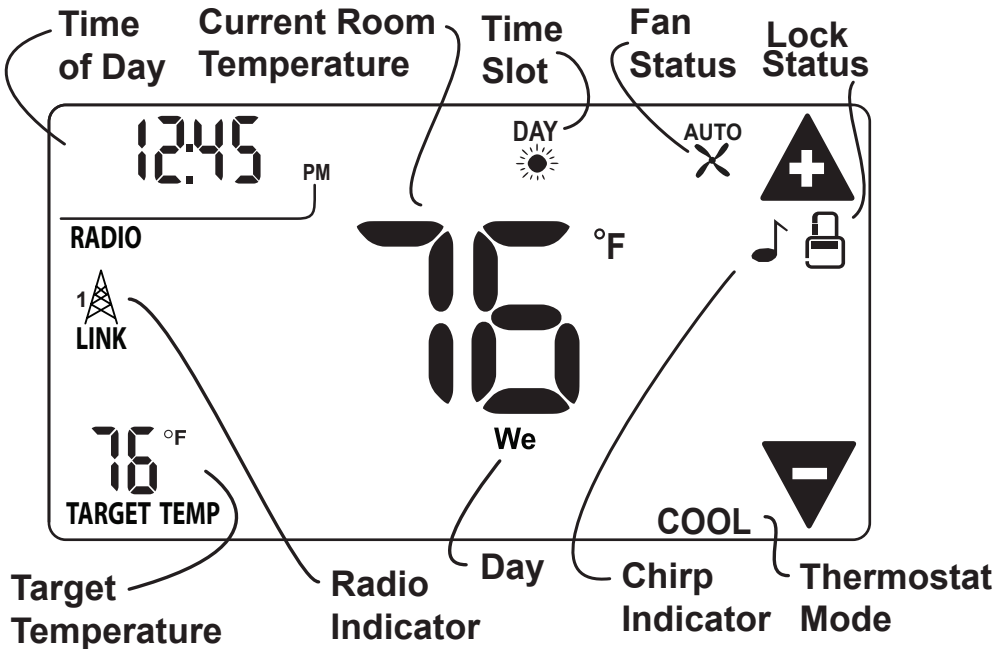
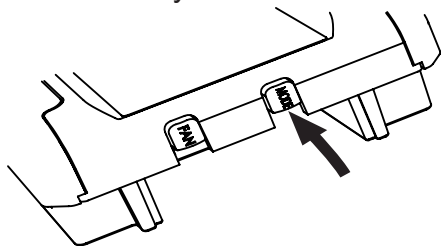

# MENU Screen

The **MENU** screen is the gateway to many functions or settings of the 3M-50. It is displayed when you press the MENU button. [See page 10 for details]

## Set Time

Touch this area to set the time of day. Left arrow goes back, right arrow goes forward.

## Filter Timer set

Touch and hold 5 sec to change.

## Chirp set

Touch this to turn the audible chirp on or off.

**Differential** to set for 2nd Stage start.

**Temperature Swing set**

## Set Day

Touch this area to set the day of the week.

## Calibration control

Use this to calibrate your LCD display match to another thermometer.

## HVAC SETUP

Touch this in OFF mode to configure the unit to work with your HVAC system.

## Lock Program

Touch for 5 sec to lock or unlock.

## Set °C °F

Touch this to set temp display units.

Return to **HOME** screen.

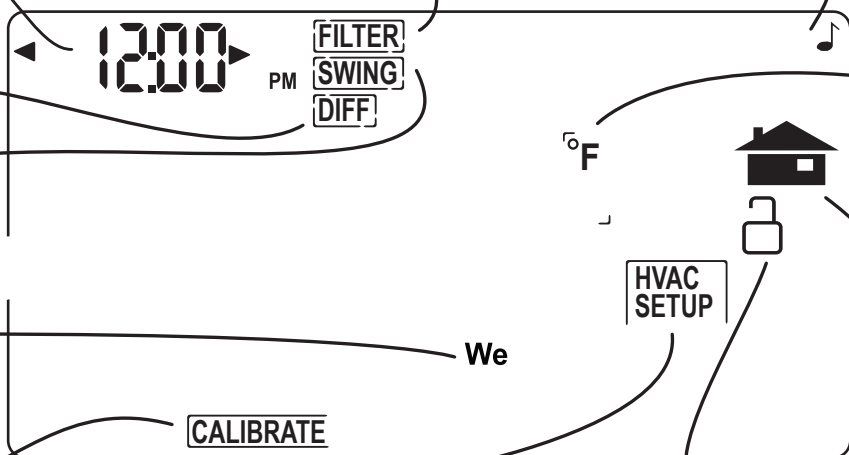

**PROGRAM Screen** The **PROGRAM** screen sets the 3M-50 control for your home HVAC system. Press and hold PROG for 10 sec to access it. After that it is displayed when you press the PROG button. [See page 8 for details]

**Set Time Slot**  
 Touch this area to set the Time Slot you want to program.

**Return HOME**  
 When programming is complete touch this to run your program and return to the HOME screen.

**Set Program Time**  
 Touch this area to set the time of day you want each time period to start. Left arrow goes back, right arrow goes forward. [Touch and hold for fast set.]

**Copy**  
 Touch this area to copy current day's program to the next day.

**Set Program Day**  
 Touch this area to set the day of the week you want to program.

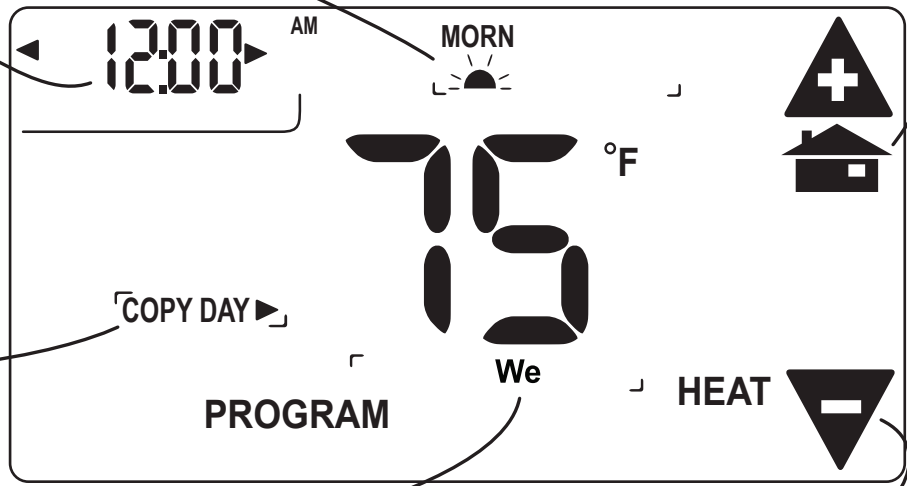

**Temp Up / Temp Down**  
 Touch these to raise and lower each Target Temp. [Touch and hold for fast set.]

# MANUAL Screen

The **Manual Screen** control screen is where you can make temporary changes to your 3M-50's operation. From the Full HOME screen, touch the main temperature display to use this screen. [See page 13 for details]

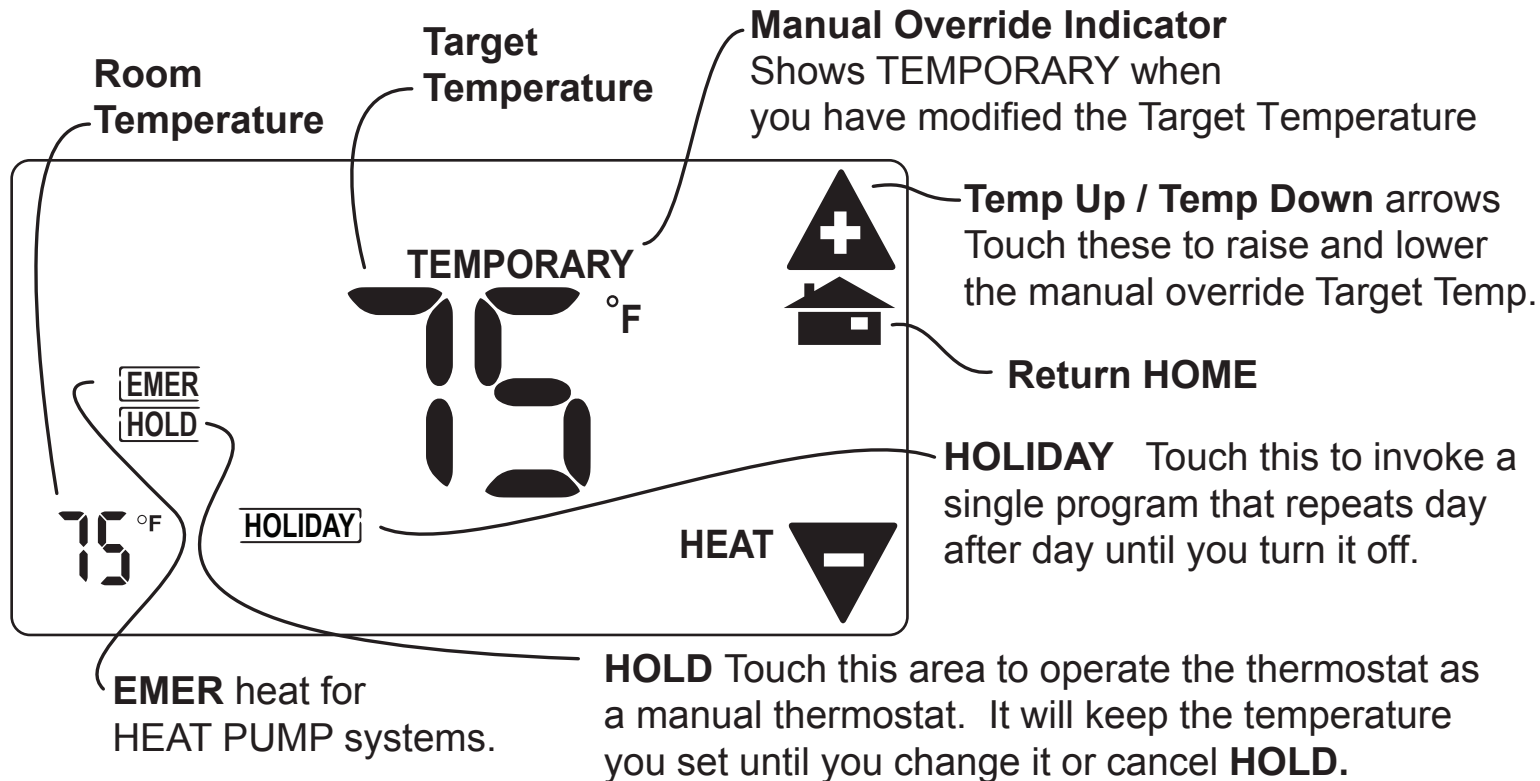

# Simple HOME Screen

Make this simple HOME screen the default for your 3M-50, switch the mode to OFF and hold the PROG button for 12 seconds. This Simple HOME screen gives you limited access to the 3M-50's features, only the target temp can be changed. [To return to the regular HOME screen switch the mode to OFF and hold the PROG button for 12 seconds.]

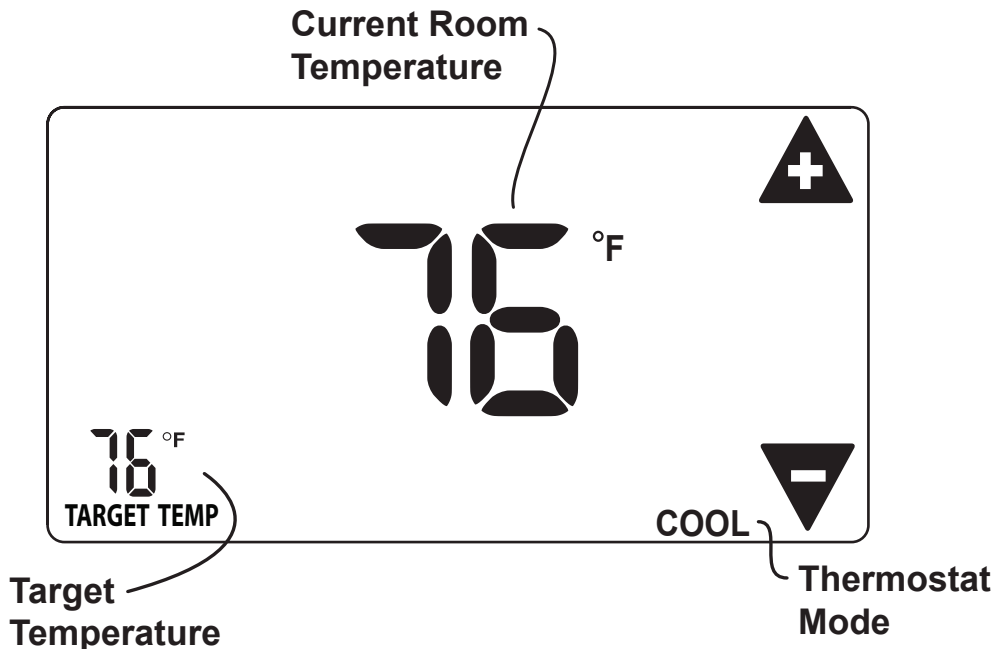

## Initial Settings

Press **MENU** to access the following commands (from HOME screen).

### Set day of the week

Touch the Day of the week area to cycle through the days of the week to select the current day.



Su Mo Tu We Th Fr Sa

### Set time of day

Touch the Time of Day arrows to move the time selection forward or backward until it displays the current time. Touch and hold for faster setting.



### Set °F-°C display

Touch the °F and it will toggle to °C.



### Set audible chirp

Touch the musical note icon to select the chirp or no chirp.

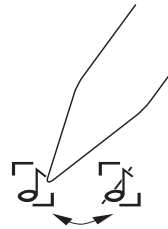

Return **HOME** by touching the home icon.

## Auto-Run Program

The 3M-50 comes pre-programmed with an EPA approved program. This program is recommended by the EPA for energy efficiency. We strongly recommend that you Auto-Run this program for one week and see if it works for you. If it does not fit your needs, you can always input a custom program.

To run the EPA program, set the mode switch to HEAT or COOL.

Press the MENU button and use the arrows by the time display to set the time.

Touch the DAY area and advance it to select the present day.

Touch HOME. The unit is now running the program.

EPA	MORN	DAY	EVEN	NITE		MORN	DAY	EVEN	NITE
HEAT	6:00am	8:00am	6:00pm	10:00pm	COOL	6:00am	8:00am	6:00pm	10:00pm
All Days	70°F	62°F	70°F	62°F	All Days	78°F	85°F	78°F	82°F

### TO CHANGE THE PROGRAM:

Make sure the 3M-50 mode is set to either HEAT or COOL, then press the **PROGRAM** button. This puts you at the **PROGRAM** screen [see page 4]. The programmed start time is displayed in the upper left. The TIME SLOT icon indicates the active TIME SLOT in the default program [MORN, DAY, EVEN, NITE]. The programmed Target Temperature is shown on main display.

The HEAT program and the COOL program are separate.



PROGRAM cont.

Select the **day** you want to program.

The day of the week starts at SU - Sunday and can be advanced to the day you want to program.

Touch the day of the week area to cycle through the days of the week to the desired day.

Select the **time slot** (period) you want to program (MORN, DAY, EVEN, NITE).

Touch the time slot area to cycle through to the desired period.

Select the desired **start time** of that time slot.

Touch the time arrows to select the desired period's starting time. Hold arrow down for fast time scrolling.

Select the desired **target temperature** for that time slot.

Touch the +/- arrows to select the desired period's temperature.

To **COPY** one day's programming to the next day, touch COPY DAY once. The information for the current day will be copied to the next day which will appear on the screen. Holding down COPY for over 3 seconds will copy to all 7 days.

Touch  to return to the Home screen.

## MENU Screen Functions

Press **MENU** to bring up **MENU** screen.

### TIME of DAY

Touch the left (backward) or right (forward) arrows next to the time display to set the current time (1 minute per touch). Touch and hold the arrow for fast time set (15 minute jumps).



**DAY of Week** Touch DAY area to select present day.

**SWING** (HVAC cycling rate) This feature allows you to set the desired variance in temperature between the 3M-50 setting and the room temperature required before the heating or cooling system will turn on—from 0.5° to 2.0° F (.25° to 1° C). For example, if SWING is set to 2.0° F and the 3M-50 is set to 70°F Target Temperature, the heat cycle will start when room temperature drops to 68°F. Similarly, the cooling system will start when the room temperature increases to 72°F. The HVAC then runs and will shut off at the Target Temperature.

To set **SWING**:

Touch SWING.

Touch the left/right arrows to set the SWING from 0.5° to 2.0°F.

The HVAC will run more frequently at .5°F and less at 2°F. Default is 1°F.

Touch  to return to the MENU screen.



**Chirp set** - Touch this to turn the audible chirp sound on or off.



**Set** - Touch this to change the temperature display scale from °F to °C .

**FILTER** - AIR FILTER ALERT - The 3M-50 can be programmed to remind you when the HVAC system's air filter needs changing.

Touch FILTER. The display will show the usage to date.

Touch FILTER for over 3 seconds and the display will change to LIMIT.

Touch arrows to set desired usage limit before filter alert comes on home screen.

When this limit is reached, FILTER will be on home screen and the CHECK FILTER indicator lights.



Limit may be set from 0 to 999 days/99 weeks; default is 90 days/12 weeks. Touch to reset.

To reset the usage back to 0, touch usage number; touching it again restores the displayed usage.

Touch  to return to the **MENU** screen.

 **LOCK** (The 3M-50 has 2 lock modes)

Touch  icon for 5 seconds; the unit will go into the PARTIAL lock mode. The user can temporarily override the 3M-50 target with the +/- buttons only. (1 bar)

For FULL lock : Touch the  (1 bar) icon again for 5 seconds to go to full lock. No changes can be made in full lock  (2 bars). Once locked, the 3M-50 will respond just to mode and menu.

To UNLOCK , Press MENU.

Touch and hold  icon for 5 seconds for 2 bars (if not there already).

Then touch and hold the  icon for another 5 seconds. Each 5 second touch and hold must be separate.

Touch  to return to the Home screen.

## **CALIBRATE**

Your thermostat was accurately calibrated at the factory to  $\pm 1^{\circ}$  F of actual ambient temperature. You do have the option, however, to change the display temperature to match that of a previous thermostat, or to match another thermostat already in your home. The range of change is from  $-6^{\circ}$ F to  $+6^{\circ}$ F or  $-3^{\circ}$ C to  $+3^{\circ}$ C.

**To change your Thermostat Calibration, touch MENU and then touch CALIBRATE.**

Use the + / - to adjust the displayed temperature up or down, as desired.

The DELTA FACTOR that appears on the screen will also automatically increase or decrease for each  $0.5^{\circ}$  (F or C) adjustment so you can see your change. The large display will show the modified temperature reading that will be displayed on the HOME screen and used as the new room temperature.

Touch  to return to the Home screen.

**DIFF** (Used for 2 stage normal or heat pump with auxiliary only, not on screen for single stage)

The differential is the number of degrees between the room temperature and the Target Temperature at which the 2nd stage will be used. Default is  $2^{\circ}$ F.

Touch MENU and then DIFF. Use the arrows to set the DIFF.  
Recommend 2°F for very cold climates and the 4°F for warm climates.

## MANUAL Screen Functions

The 3M-50 has 4 manual override commands. The manual screen is accessed by touching the large current temperature display in the middle of the HOME screen.

**IMPORTANT:** The Mode must be in HEAT or COOL to access the manual screen.

**TEMPORARY override** Touch the + / - arrows to select your desired temporary Target Temperature. Touch HOME to return to operation. The **TEMPORARY** icon will display indicating you have modified the Target Temperature for the current Time Slot only. It goes back to the program target at the next period. Also, when in **TEMPORARY**, if the target is set the same as the programmed target for that period, the word **TEMPORARY** will go out.

**HOLD** This will hold the target temperature you set indefinitely, until you turn **HOLD** off. **HOLD** will allow you to operate your thermostat as a manual thermostat. It will keep whatever temperature you set until you change it or cancel hold. Take care using the **HOLD** function as the program is now bypassed. To set a hold target temperature, touch **HOLD** and use the +/- icons to select your hold temperature. The **HOLD** icon will display on the HOME screen indicating you have changed the Target Temperature. The system

will **HOLD** this temperature until you return to the manual screen and de-select **HOLD** by touching it. Hold is also canceled when you set the mode to OFF.

**HOLIDAY** This is a single program that repeats day after day until you turn it off. It supersedes the weekly program. To use it touch **HOLIDAY** on the temporary screen. The default holiday program is shown here [Default program: HEAT 70°F all day and 62°F at night. COOL 78°F all day and 82°F at night.] To modify this program, touch the PROGRAM button and then touch the DAY area until HOLIDAY appears (after SAT). The default HOLIDAY program is set as 2 time slots; all day (same target MORN, DAY and EVEN) and a different target for NITE.

**EMER** (in HEAT PUMP type)

If you set your 3M-50 for HEAT PUMP with auxiliary heat, EMER function is available on the MANUAL screen. If you touch EMER, it displays EMER|ON. Your HEAT PUMP is disabled and auxiliary heat is your sole source of heat. This manual override stays active until you toggle EMER off. Auxiliary heat is more expensive than the heat pump so use EMER only if the heat pump cannot keep up or is defective.

## Other Functions

### Save Energy Button

The “Save Energy” feature on the 3M-50 provides a simple, easy-to-use way to help you manage your energy use. SAVE ENERGY automatically adjusts your Target Temperature up in COOL or down in HEAT by 4°F. To use Save Energy, press the Save Energy button in the upper left corner of the unit. The screen will now read “Save Energy”. To return to normal operation, press the “Save Energy” button again. This is useful to save energy if you are gone for a short time.

## **MODE Button**

The mode button sets the 3M-50 to HEAT, COOL, AUTO, or OFF modes. Press it once to step to the next mode. If the 3M-50 is in OFF and you want to return to the mode you were previously in, touch the OFF indicator on screen.

**COOL** - This will operate the cooling portion of your HVAC system until it is turned off.

**HEAT** - This will operate the heating portion of your HVAC system until it is turned off.

**AUTO** - The 3M-50 TRUE AUTO mode switches automatically between heat and cool throughout the year. Unlike other manufacturers, the 3M-50 TRUE AUTO has no temperature or time limitations (Patent pending), just program your desired HEAT and COOL temps and select the AUTO mode. The 3M-50 will switch from HEAT to COOL as needed.

**OFF**- This takes your HVAC system “off-line” and it will not control HVAC functions. In this mode your house may experience extreme heat or cold.

## **FAN Button**

The fan control is normally in AUTO mode, meaning that the fan operates automatically with the HVAC system and the thermostat. When the fan button is pressed the fan goes ON; the fan will run continuously in this manual override until switched back to AUTO by pressing the FAN button again.

[NOTE: Fan **ON** function is available in the OFF mode to allow simple ventilating.]

## **Simple Screen**

This display mode limits the amount of information on screen and limits the functions to just the +/- arrows and the MENU button. Set mode to OFF and ...

Hold down the PROGRAM button for 12 seconds to access the limited display screen.

Hold down the PROGRAM button for 12 seconds to leave the limited display screen.

**RESET button** The RESET button re-boots the 3M-50 processor. It does not effect the user programs that have been stored in permanent memory.

**Compressor Protection** The 3M-50 has a minimum cycle time of 4 minutes to protect your compressor in cool and in heat pump (if you have one). The Home screen will show a small clock and A/C during this time and the compressor will not come on until the 4 minute delay is over.

## Communicating Thermostat

The 3M-50 has 2 RTM-1 radio ports. These allow your thermostat to communicate with other systems.

**Using USNAP Radios** The USNAP ports allow you to connect your 3M-50 to your home WiFi network. This can give you access to your home's HVAC system even when you are away [with additional web service]. It can also give you access to web based efficient energy management sites that can help you save money and protect the environment. You can connect your 3M-50 to a Home Automation network for HA functionality with remote access to your HVAC system and home conditions.

### To Insert a USNAP radio module:

Power off the 3M-50. Insert the radio module in either slot on the back of the 3M-50. Power up 3M-50.

**To connect** to a network follow the instructions that came with the USNAP module.

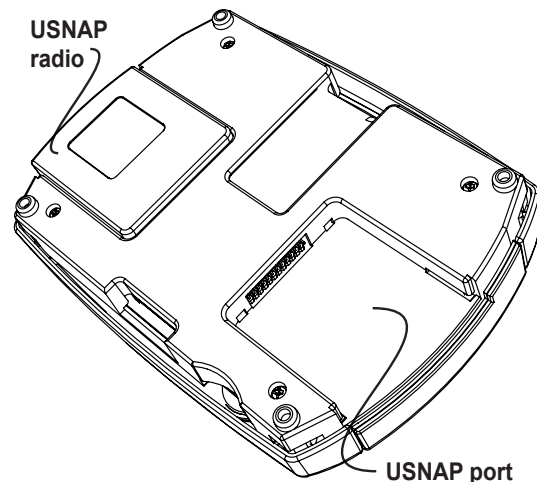

### ⚠ Caution

**DO NOT INSERT or REMOVE USNAP** radio modules if power is ON. This can damage the thermostat or radio modules.